

PLANTAS 1 - 7

**VIVIENDA TIPO 1 / 4D+E**  
superficie CONSTRUIDA - C/PPEC: 225,58 M<sup>2</sup>

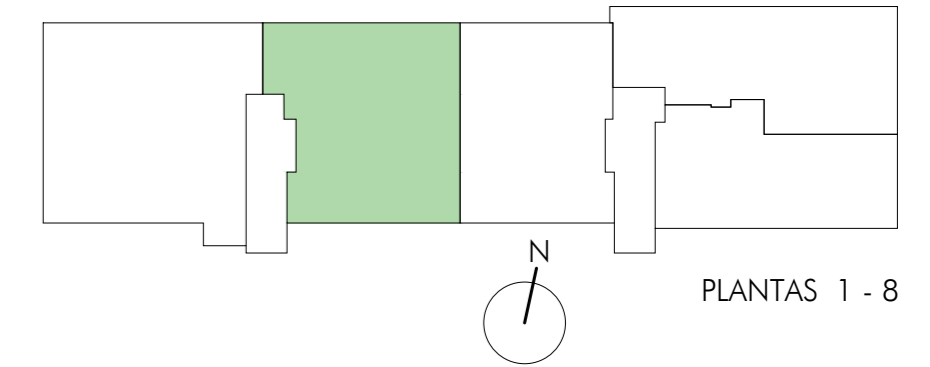



**VIVIENDA TIPO 2 / 4D**  
superficie CONSTRUIDA - C/PPEC: 194,07 M<sup>2</sup>



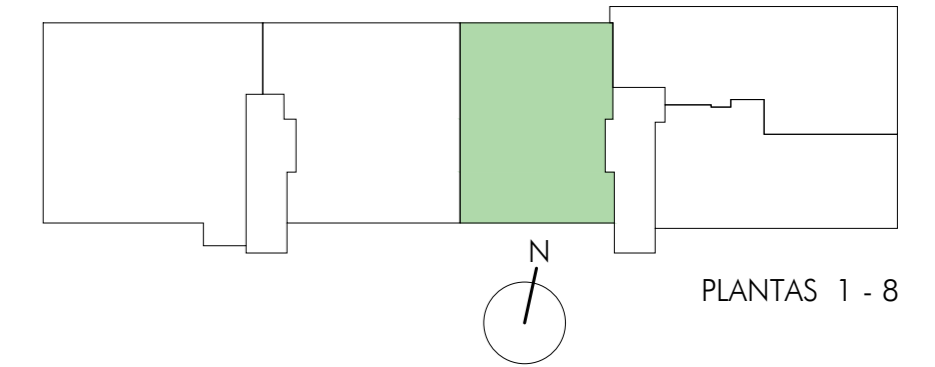

**VIVIENDA TIPO 3 / 3D**  
superficie CONSTRUIDA - C/PPEC: 164,76 M<sup>2</sup>

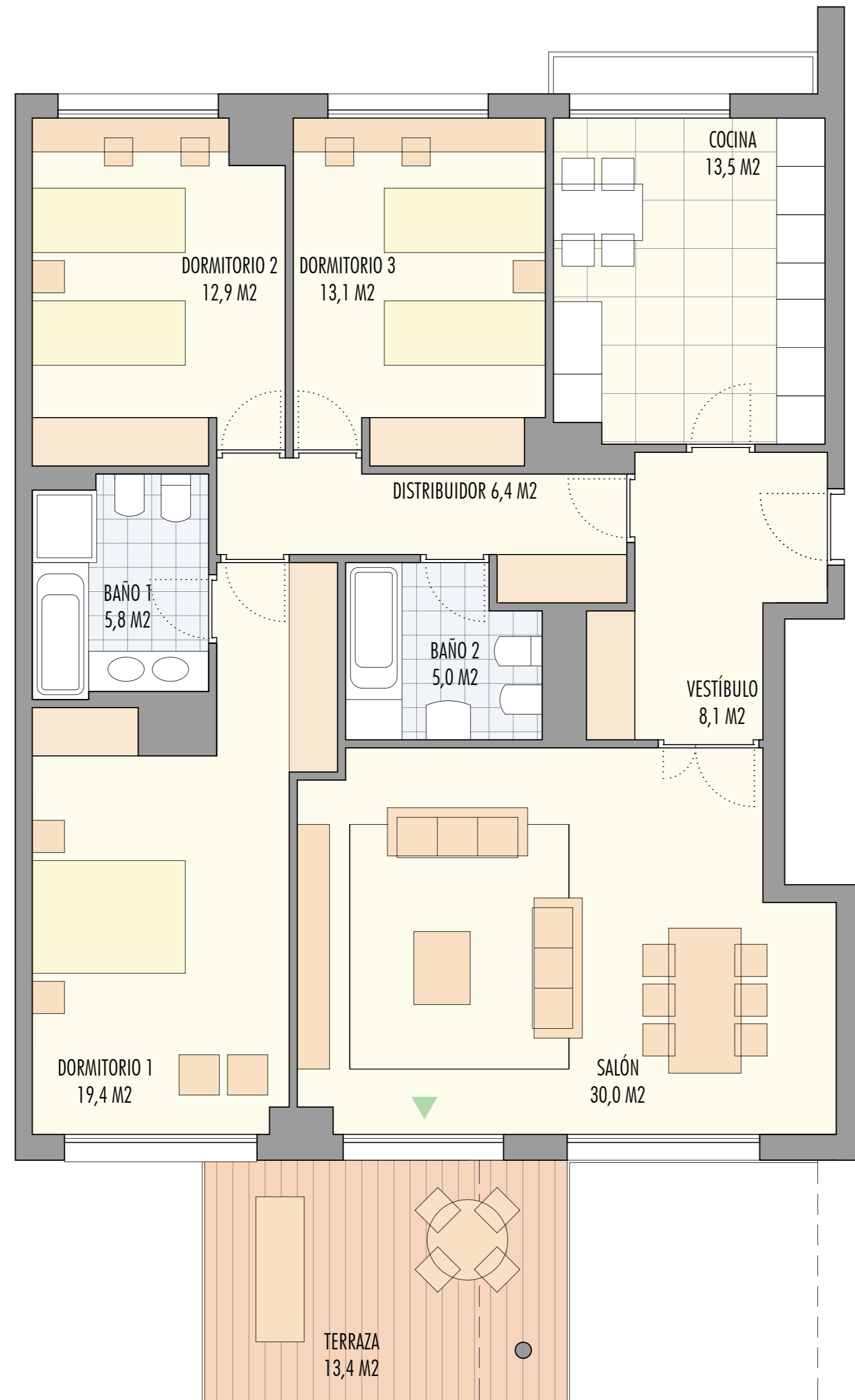

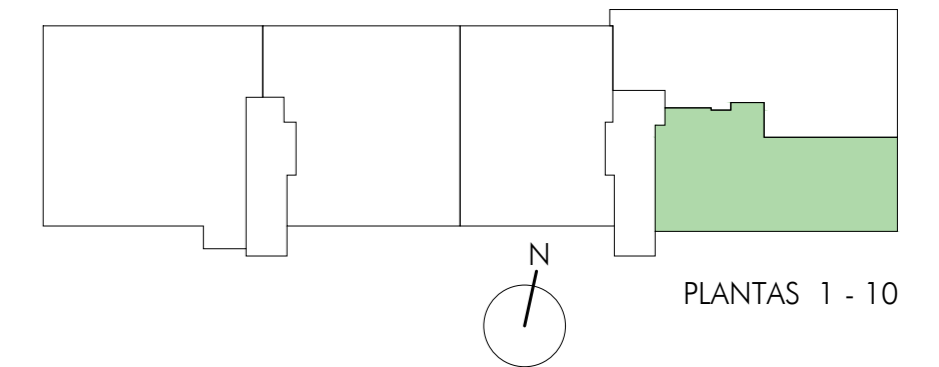

**VIVIENDA TIPO 4 / 3D**  
superficie CONSTRUIDA - C/PPEC: 137,13 M<sup>2</sup>



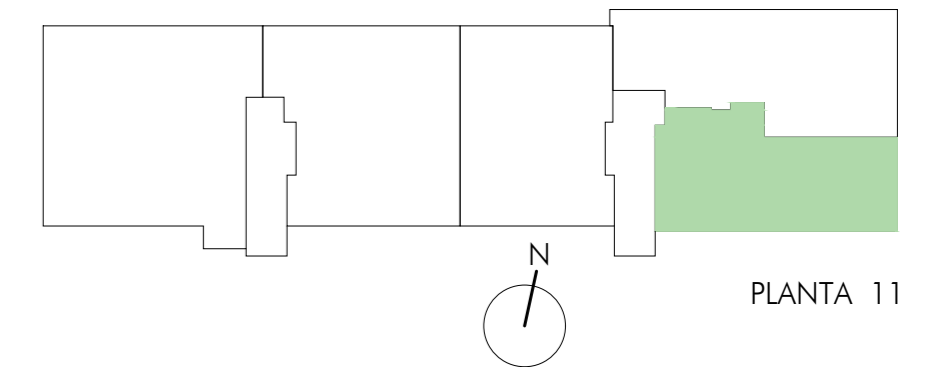

**VIVIENDA TIPO 4S / 3D**  
superficie CONSTRUIDA - C/PPEC: 140,10 M<sup>2</sup>

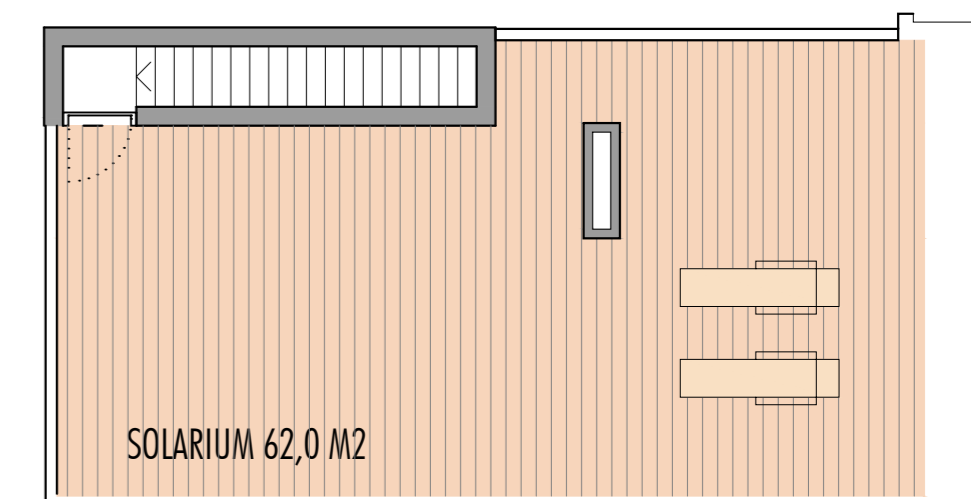
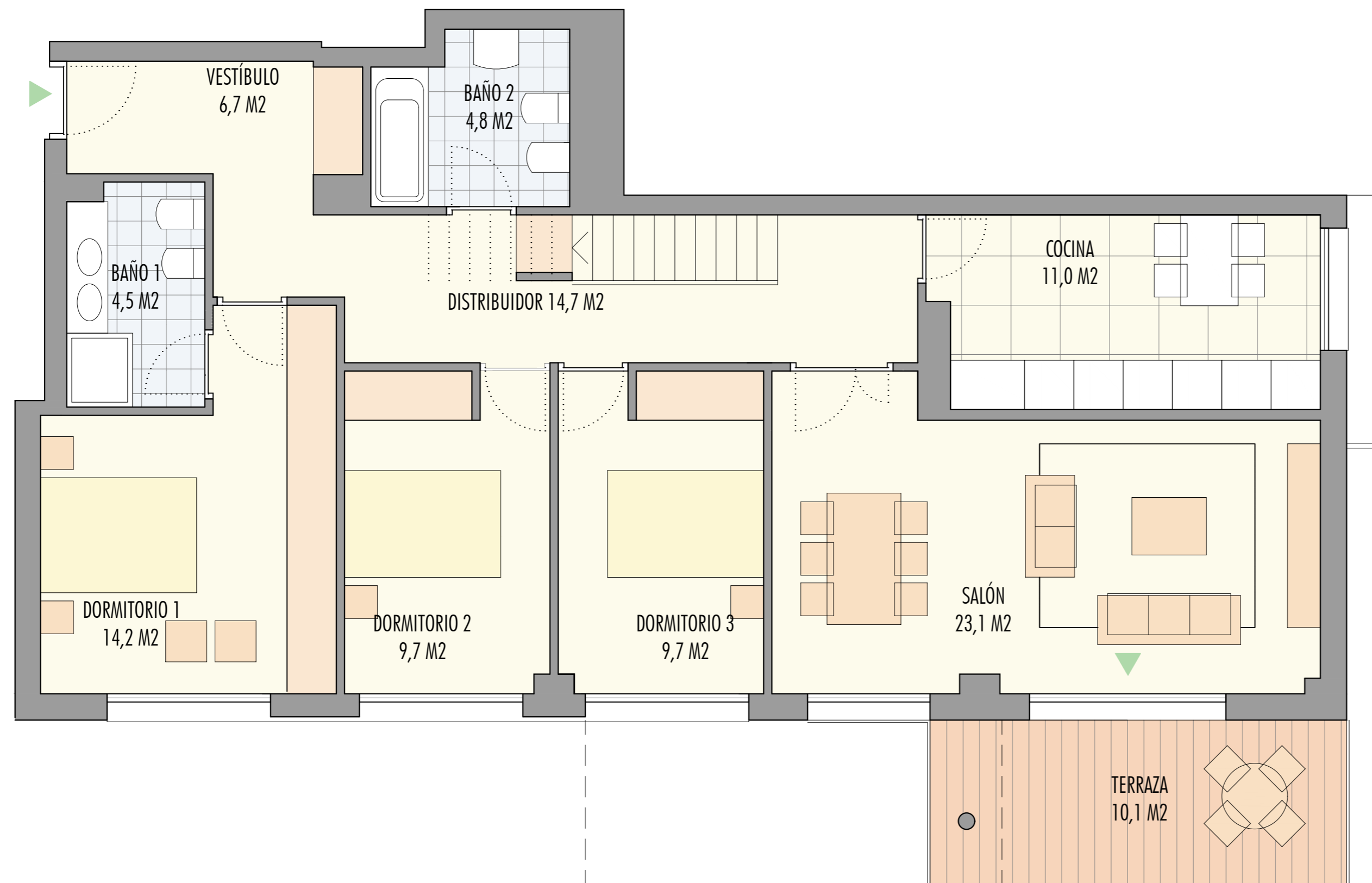

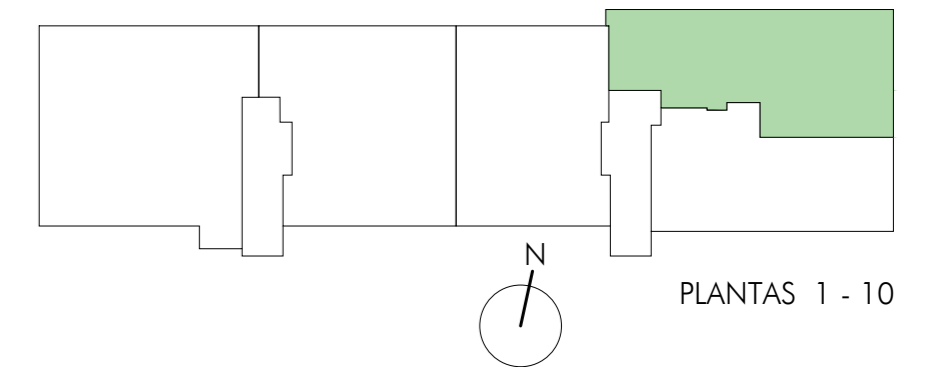

PLANTAS 1 - 10

**VIVIENDA TIPO 5 / 4D**  
superficie CONSTRUIDA - C/PPEC: 153,40 M<sup>2</sup>

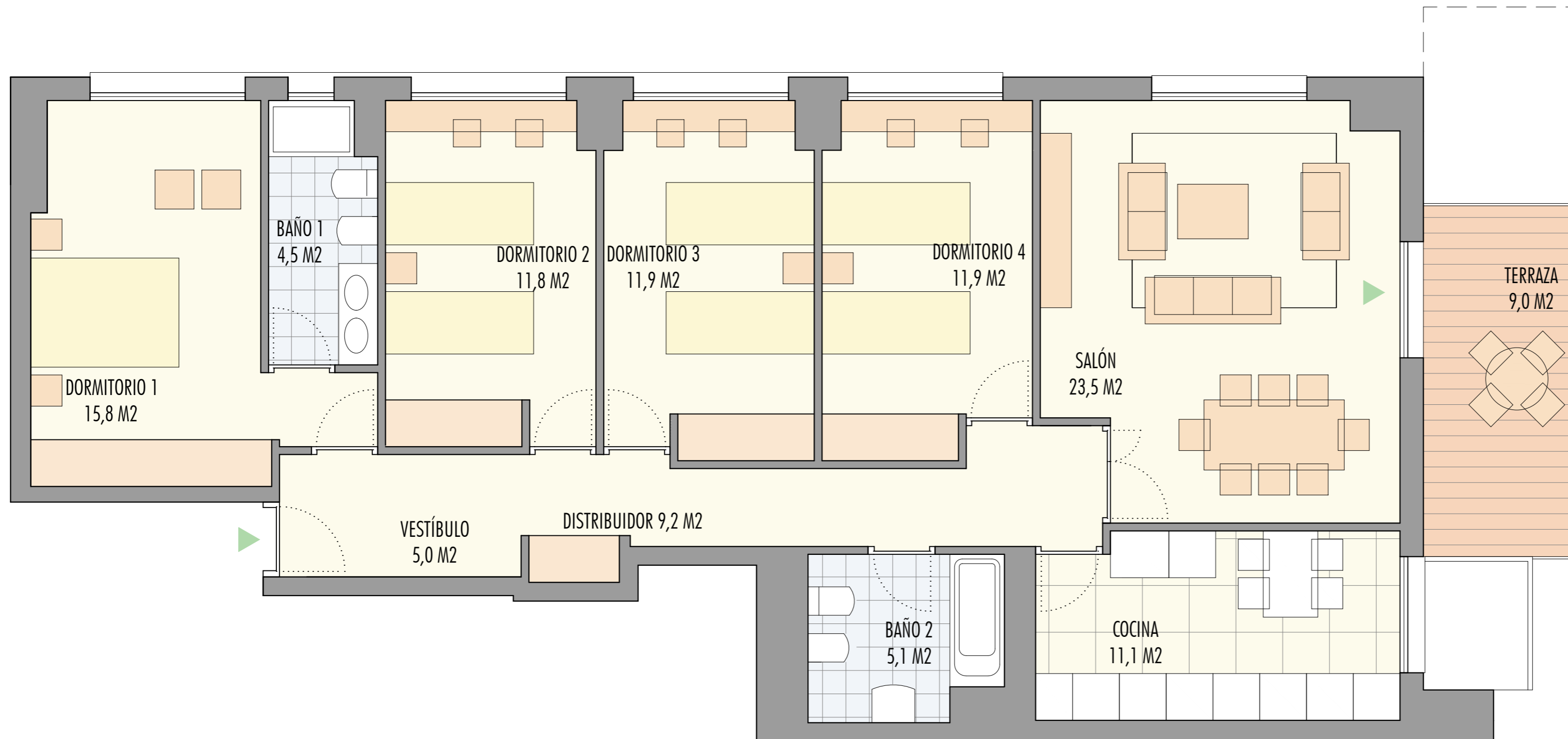

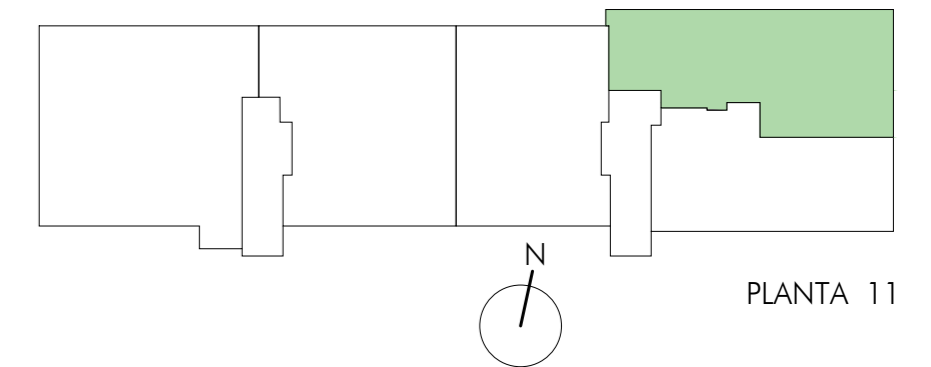

PLANTA 11

**VIVIENDA TIPO 5S / 4D**  
superficie CONSTRUIDA - C/PPEC: 156,75 M<sup>2</sup>

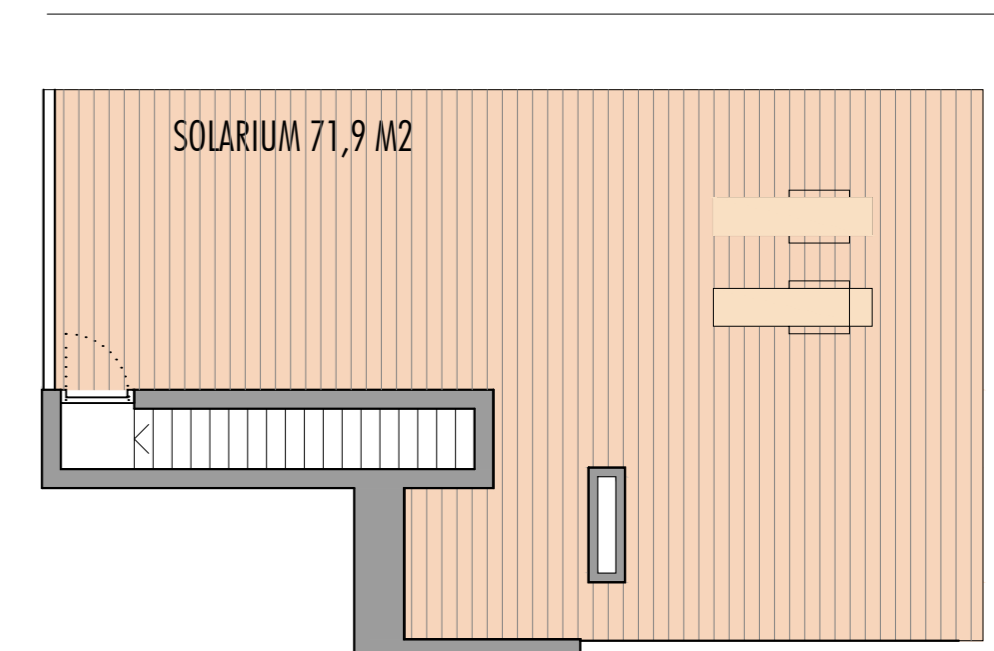
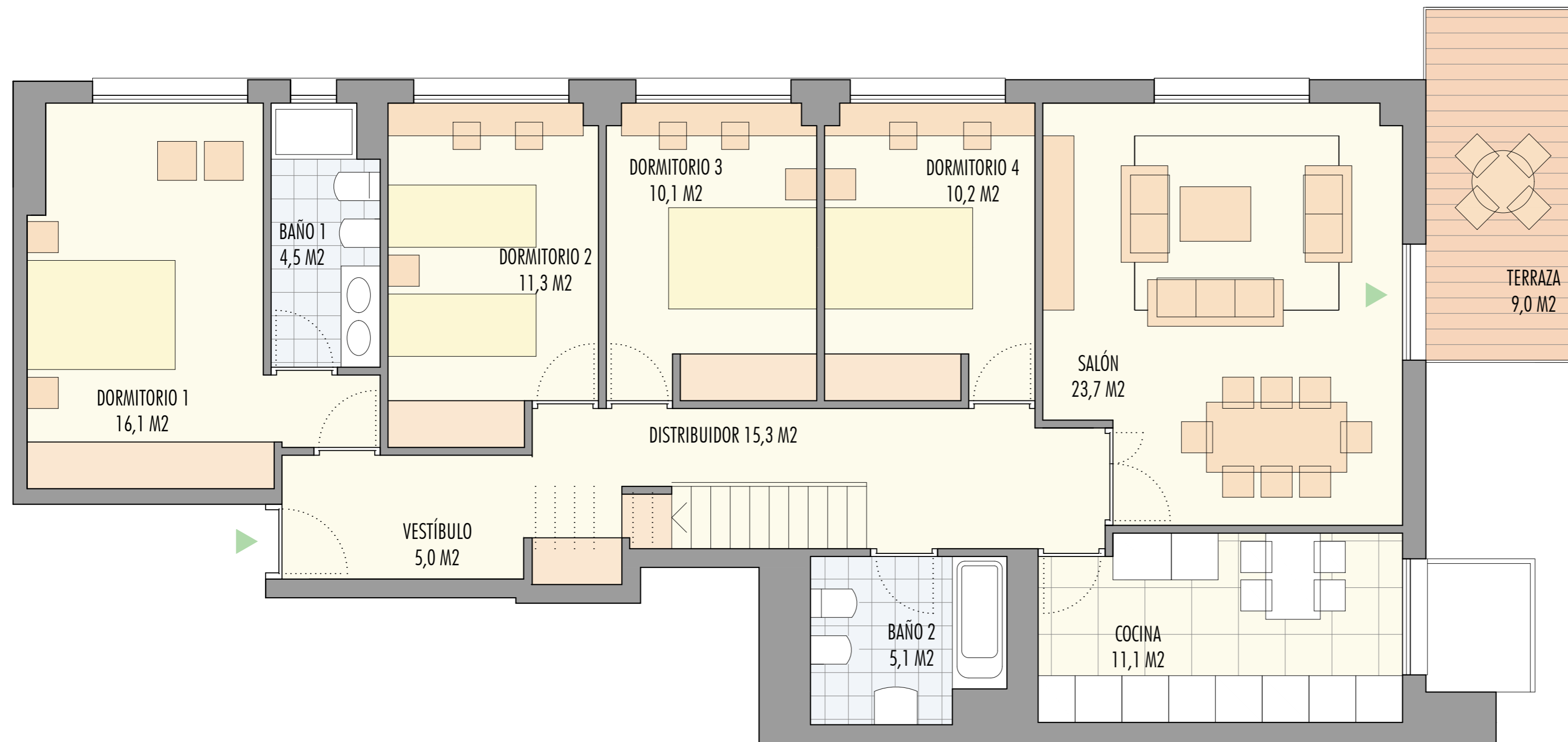

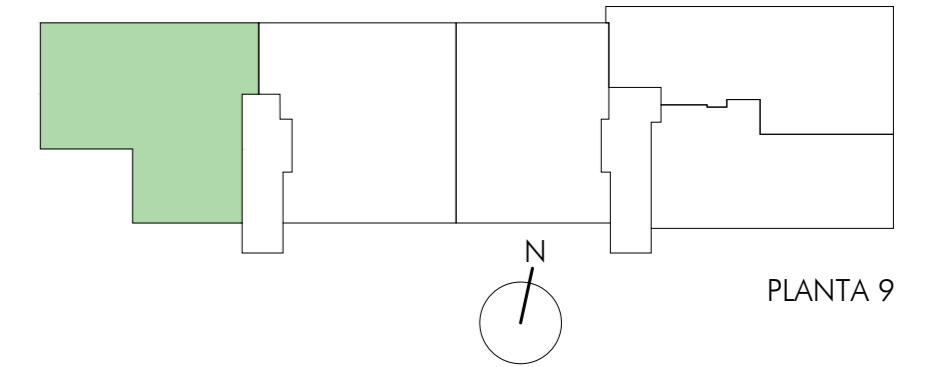

**VIVIENDA TIPO 6 / 4D**  
superficie CONSTRUIDA - C/PPEC: 179,48 M<sup>2</sup>





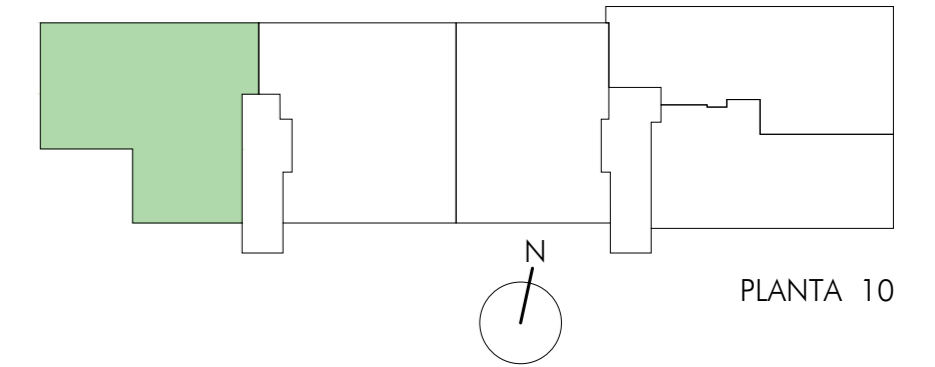

**VIVIENDA TIPO 6 / 4D**  
superficie CONSTRUIDA - C/PPEC: 179,48 M<sup>2</sup>



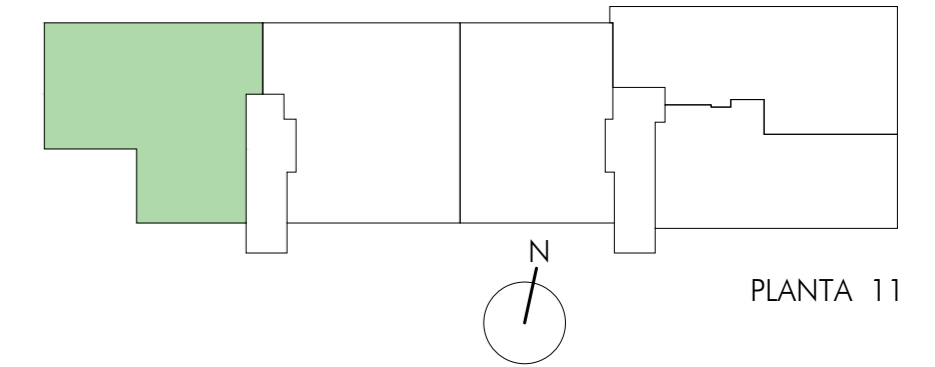

PLANTA 11

**VIVIENDA TIPO 6S / 4D**  
superficie CONSTRUIDA - C/PPEC: 181,42 M<sup>2</sup>

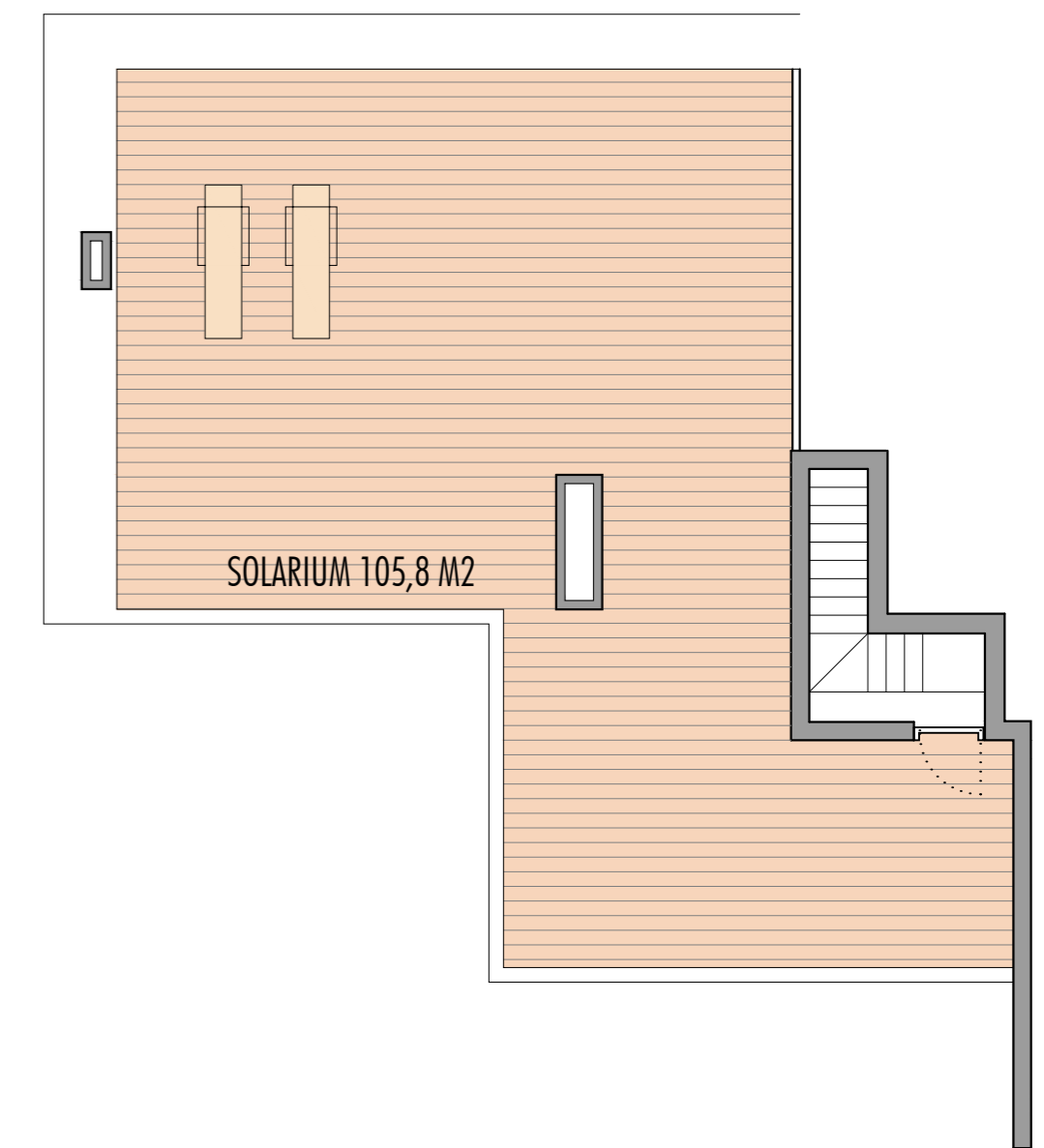

SOLARIUM 105,8 M<sup>2</sup>

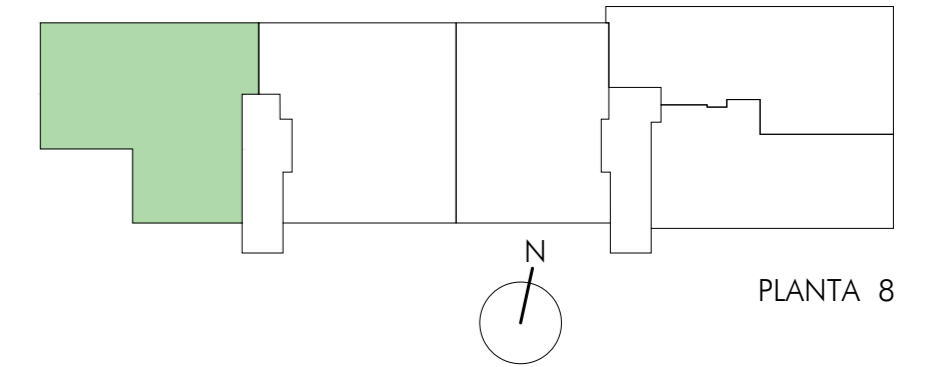

PLANTA 8

**VIVIENDA TIPO 6\* / 4D**  
superficie CONSTRUIDA - C/PPEC: 165,79 M<sup>2</sup>



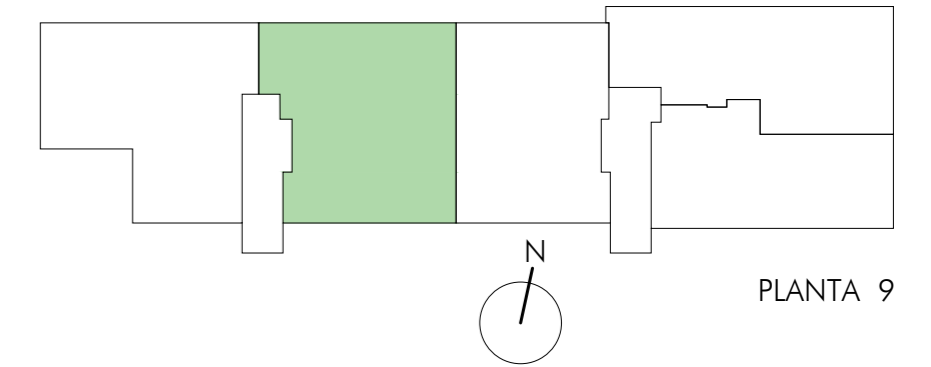

PLANTA 9

**VIVIENDA TIPO 7 / 4D**  
superficie CONSTRUIDA - C/PPEC: 186,45 M<sup>2</sup>



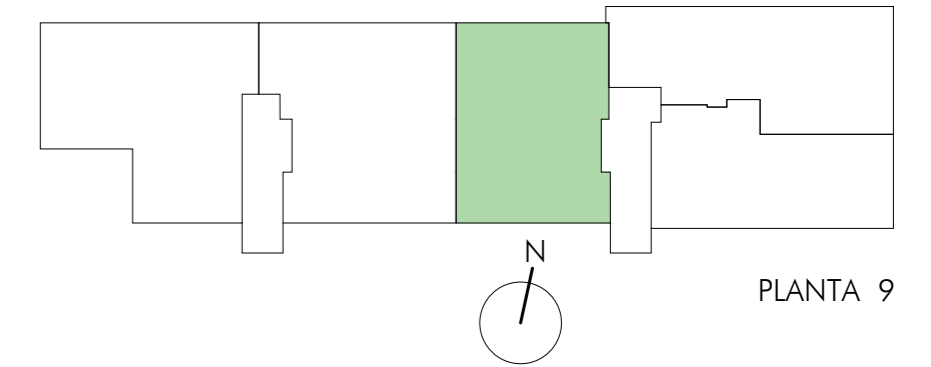

PLANTA 9

**VIVIENDA TIPO 8 / 3D**  
superficie CONSTRUIDA - C/PPEC: 154,69 M<sup>2</sup>

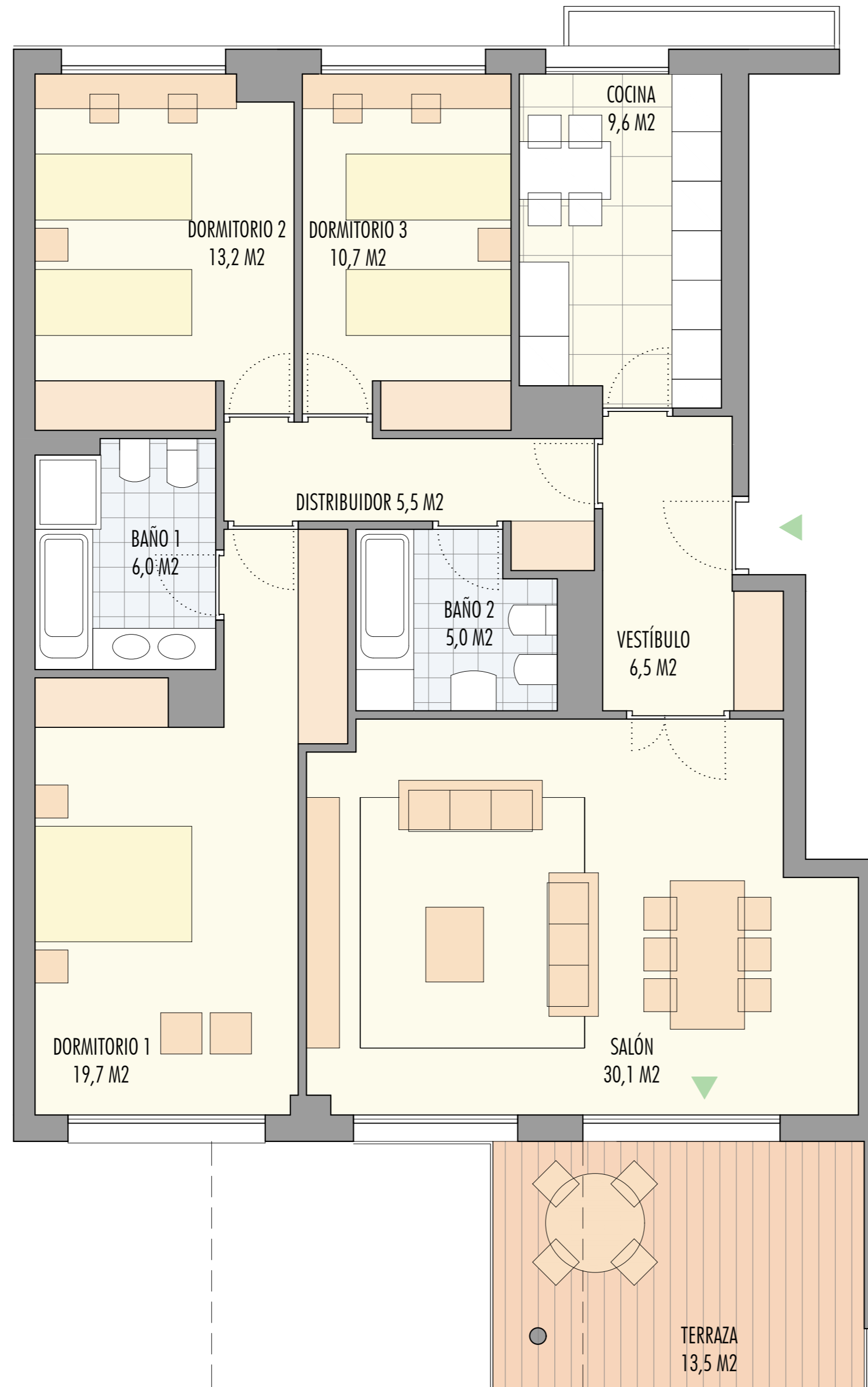

**VIVIENDA TIPO 9A / 4D**  
superficie CONSTRUIDA - C/PPEC: 193,55 M<sup>2</sup>

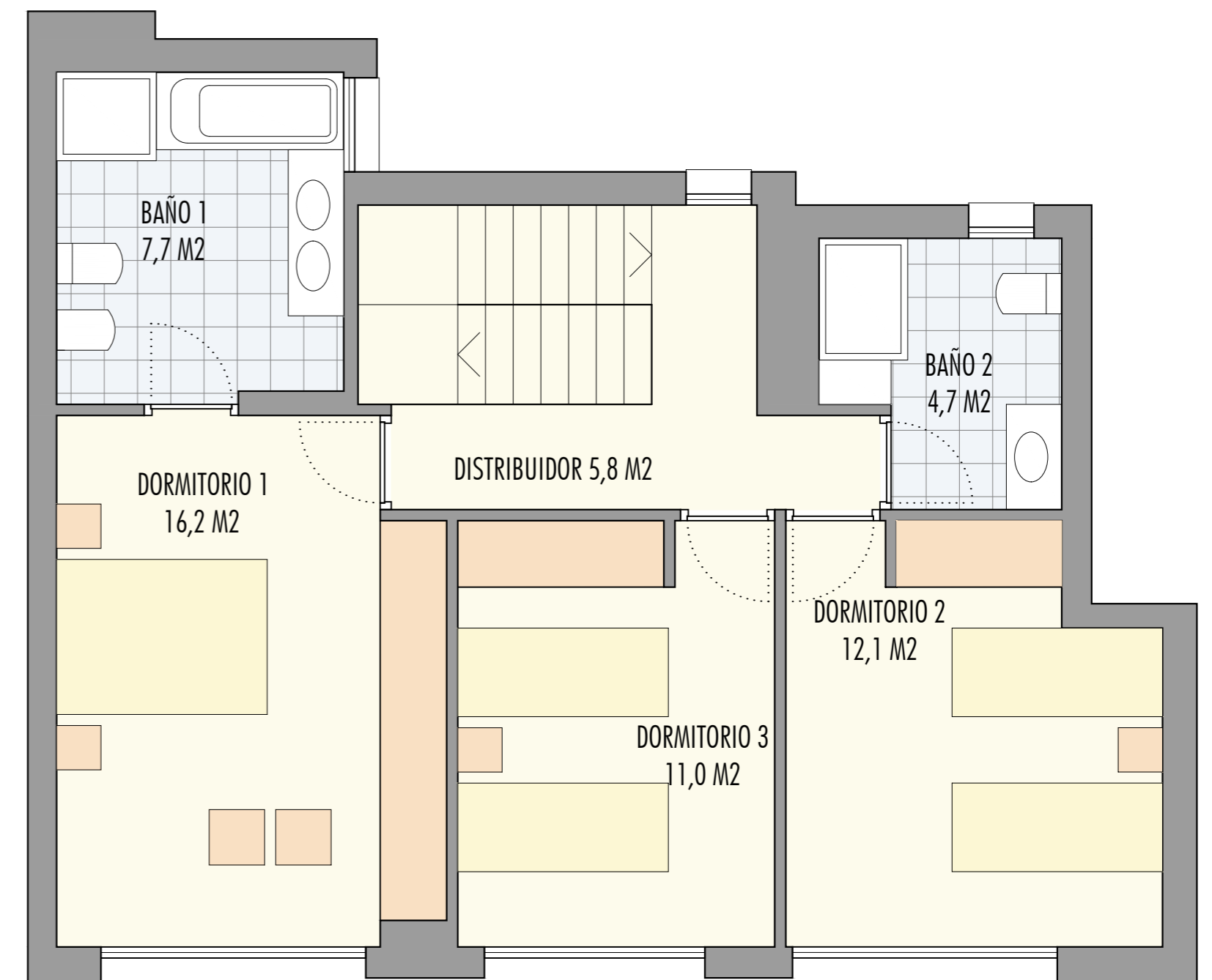
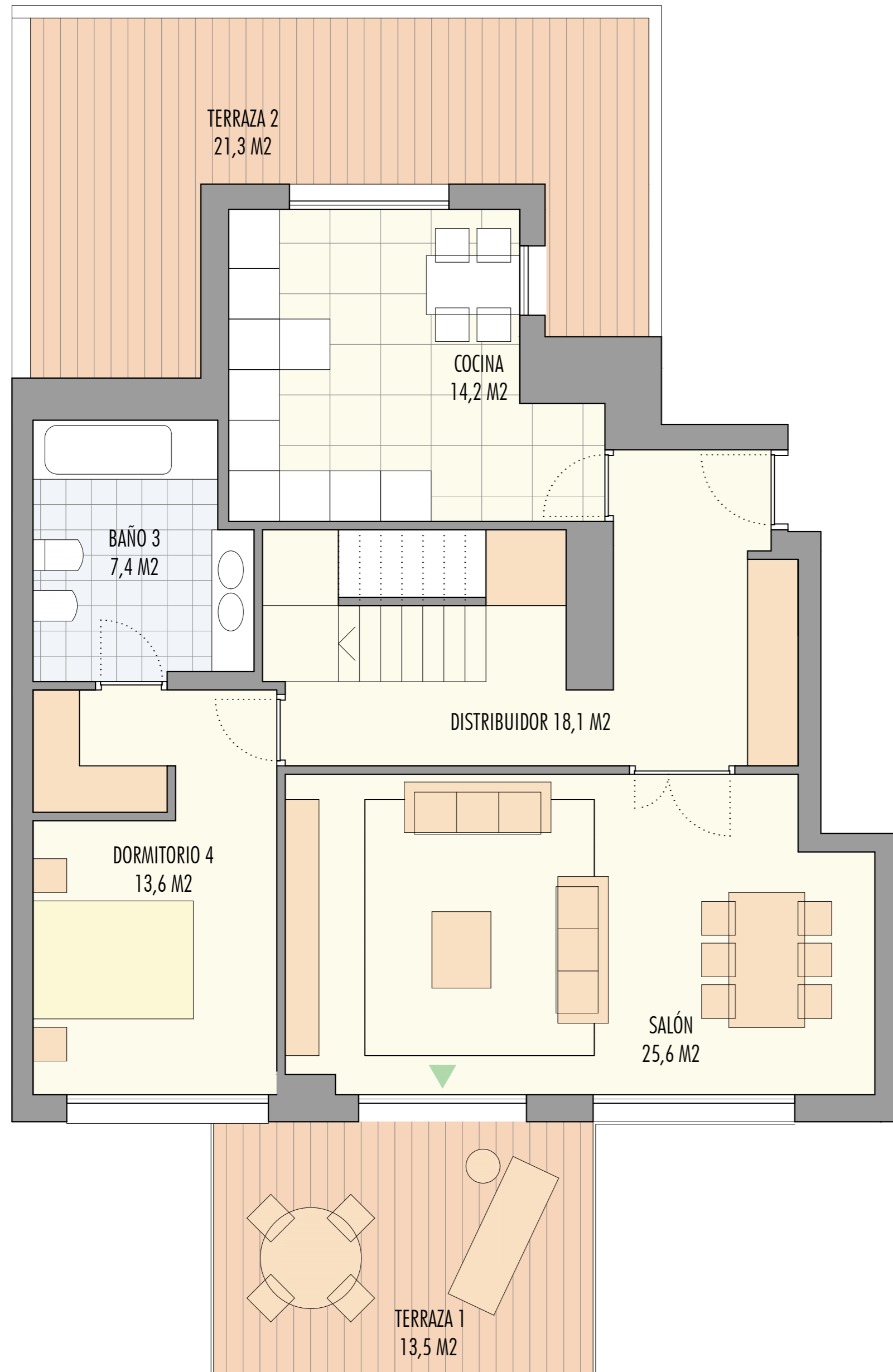
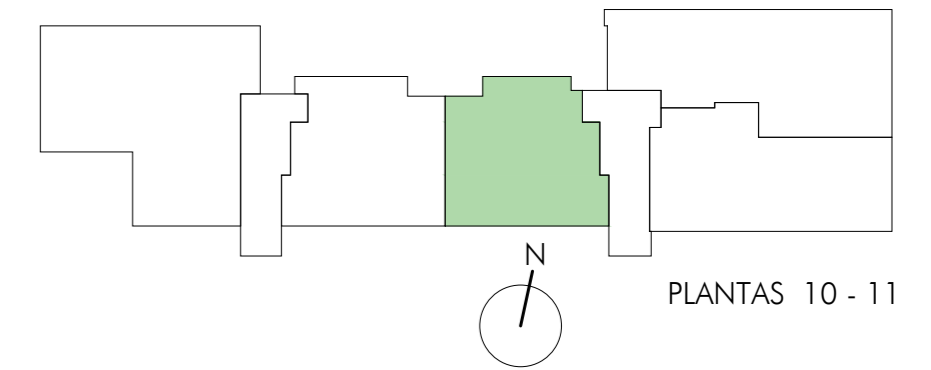

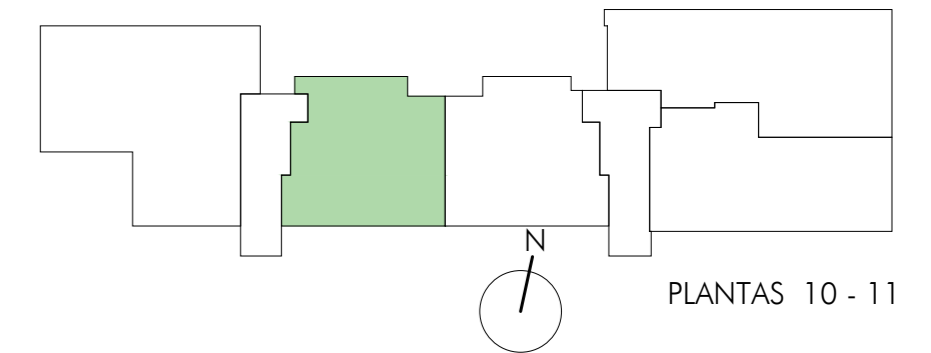

**VIVIENDA TIPO 9B / 4D**  
superficie CONSTRUIDA - C/PPEC: 217,57 M<sup>2</sup>

